



CONE CLIMBER 1800

TAY- CC05-CC1800-00
EN1176-1:2017 | EN1176-11:2014



3+

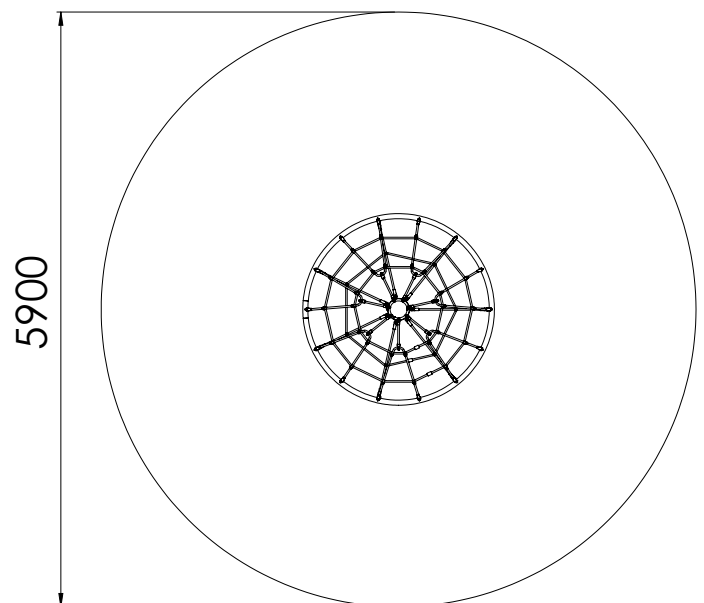
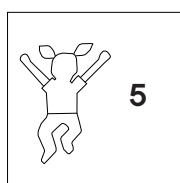
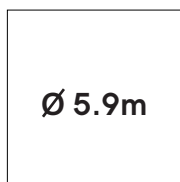
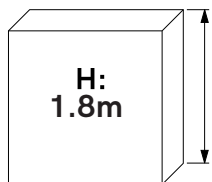
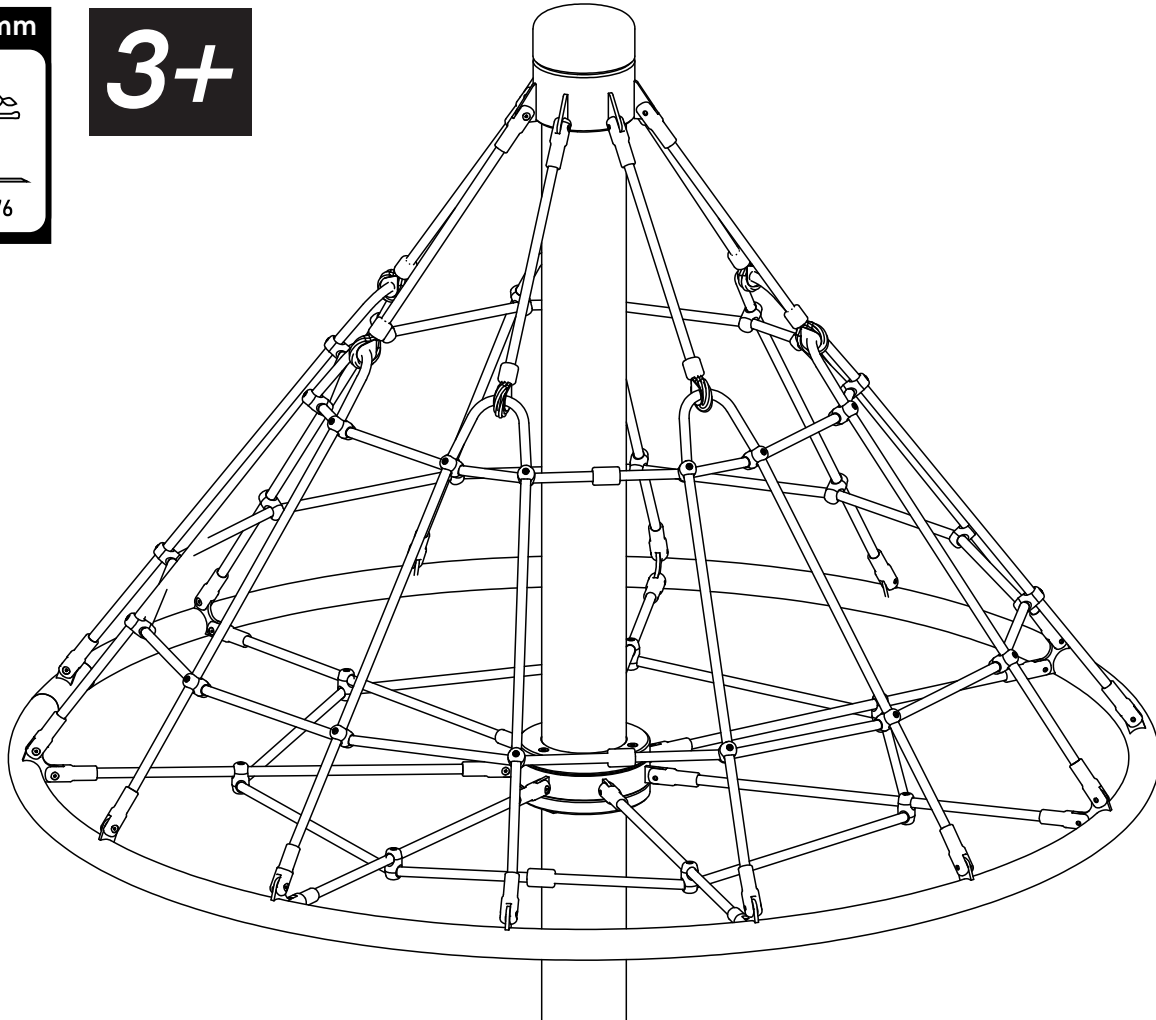



Polished Dome Cap and Thurst Bearing



Speed Restricting Friction Collar



Stainless Steel Mast

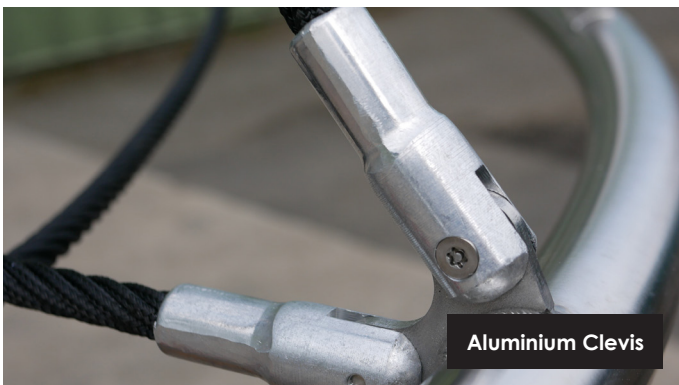

Aluminium Clevis



Tayplay's Secure Pressed Aluminium Connector

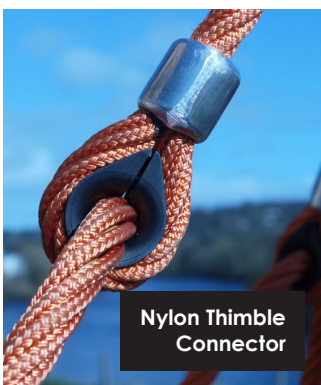

Nylon Thimble Connector



Fibre Core

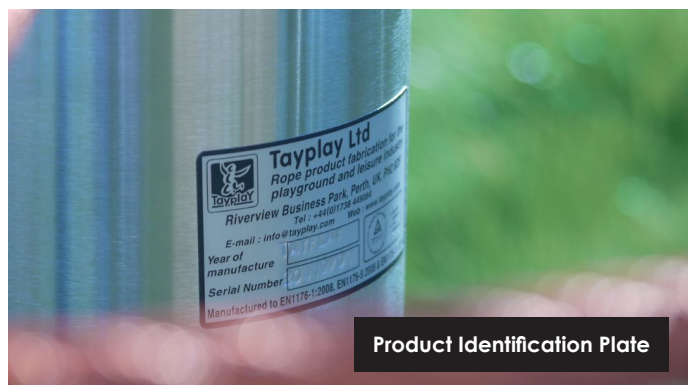

Product Identification Plate