

EN 1176



S6

EN1176

1.60m

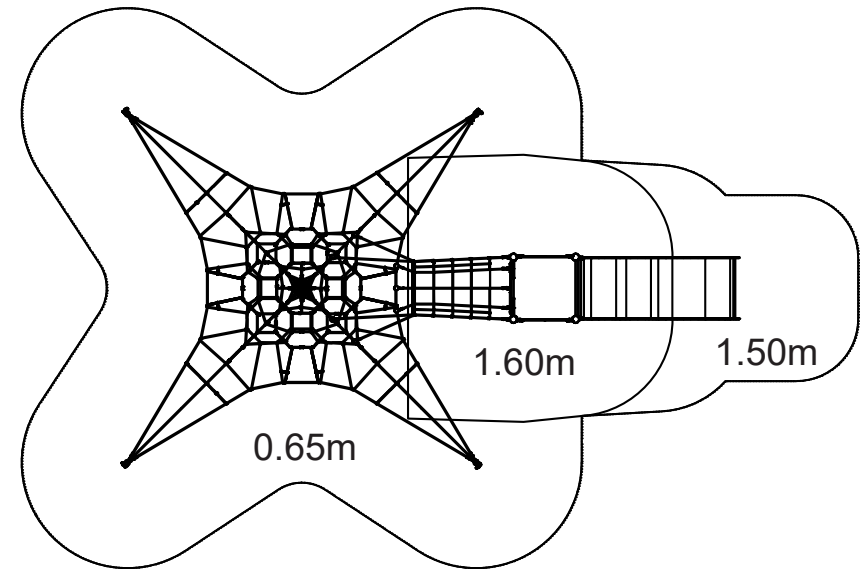
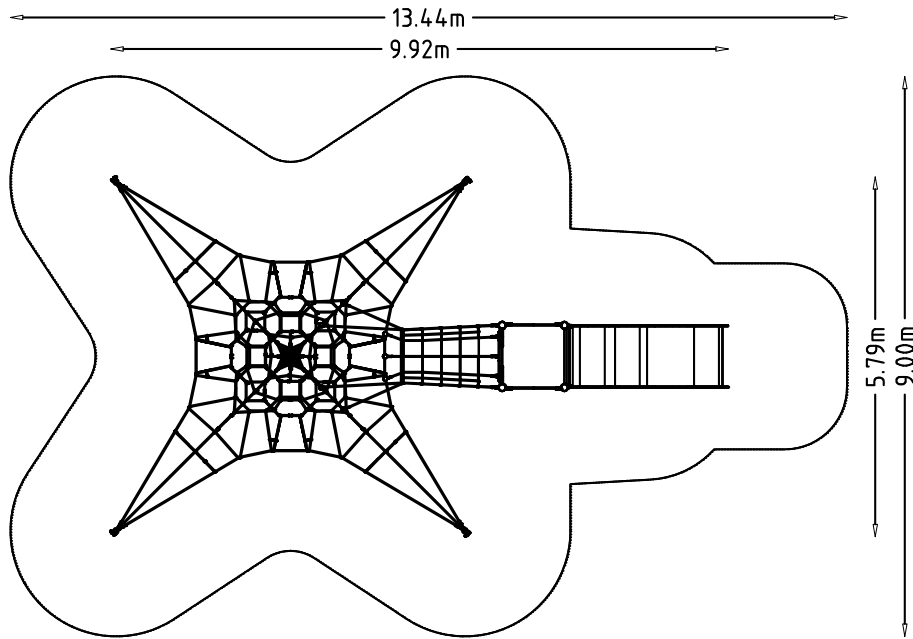

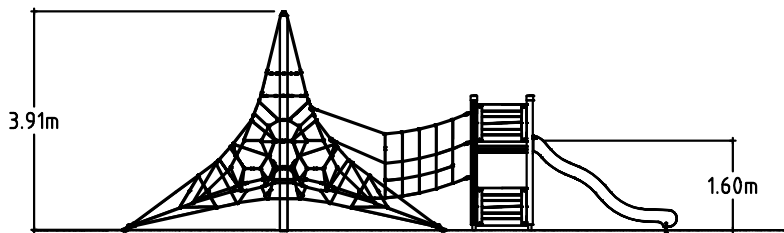
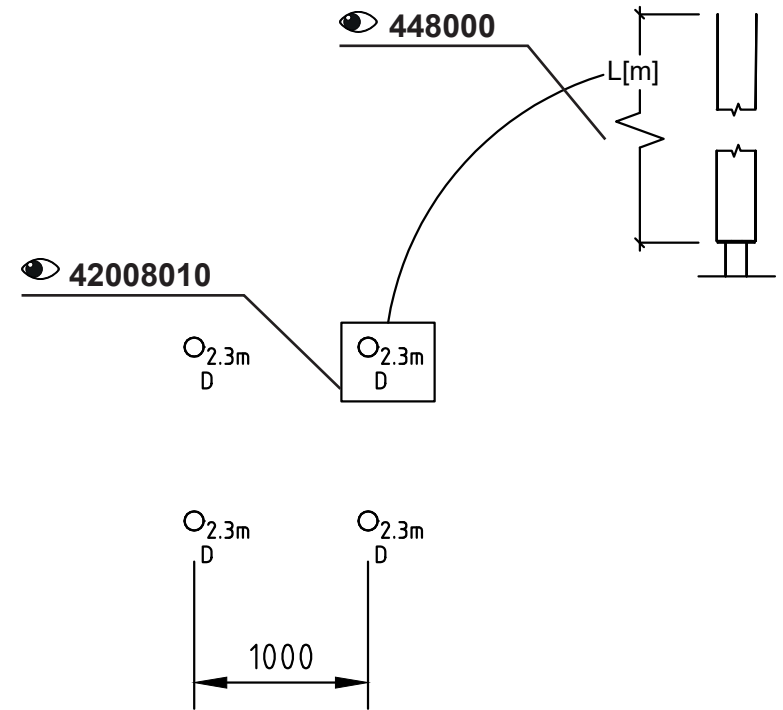
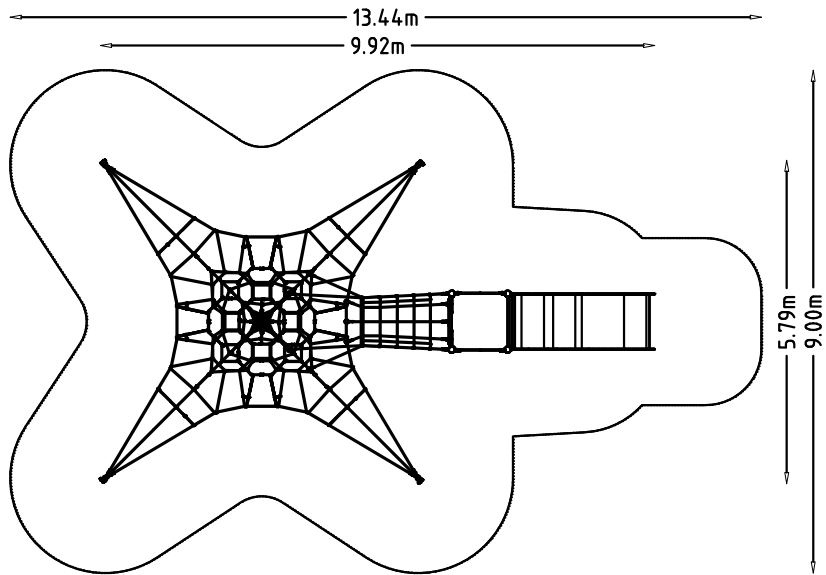

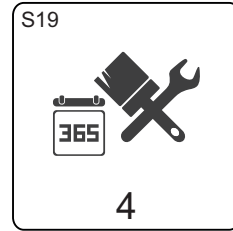
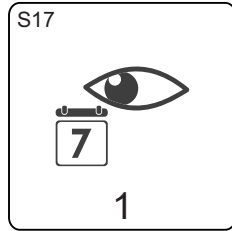
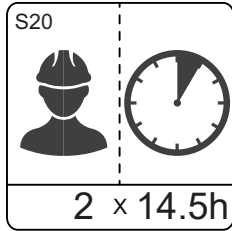

**448000**  
**42008010**  
**Active4000**  
**MASW39775**  
**MASW36415**  
**MASW67941[Sf]**  
**MASW67923[OM]**  
**MASW67943[BM]**  
**260329**

42008010

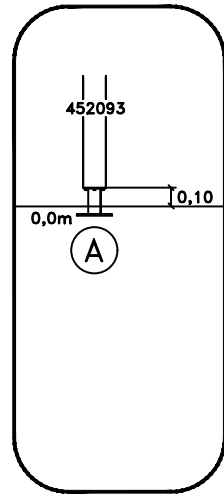

**OM**

**Above Ground**

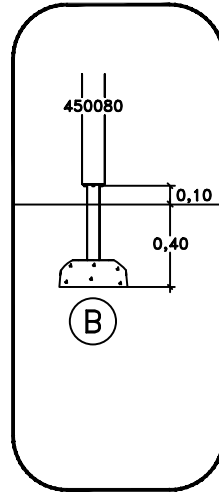

**SF**

**Sunken Foundation**

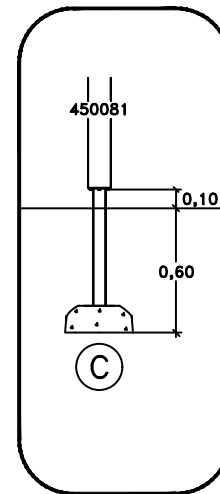

**SF**

**Sunken Foundation**

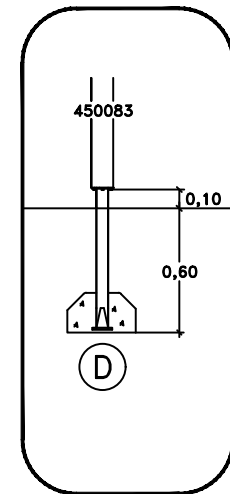

**CC**

**Cast In Place**

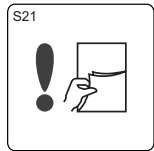
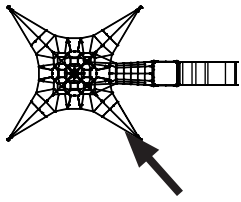

Active 4000

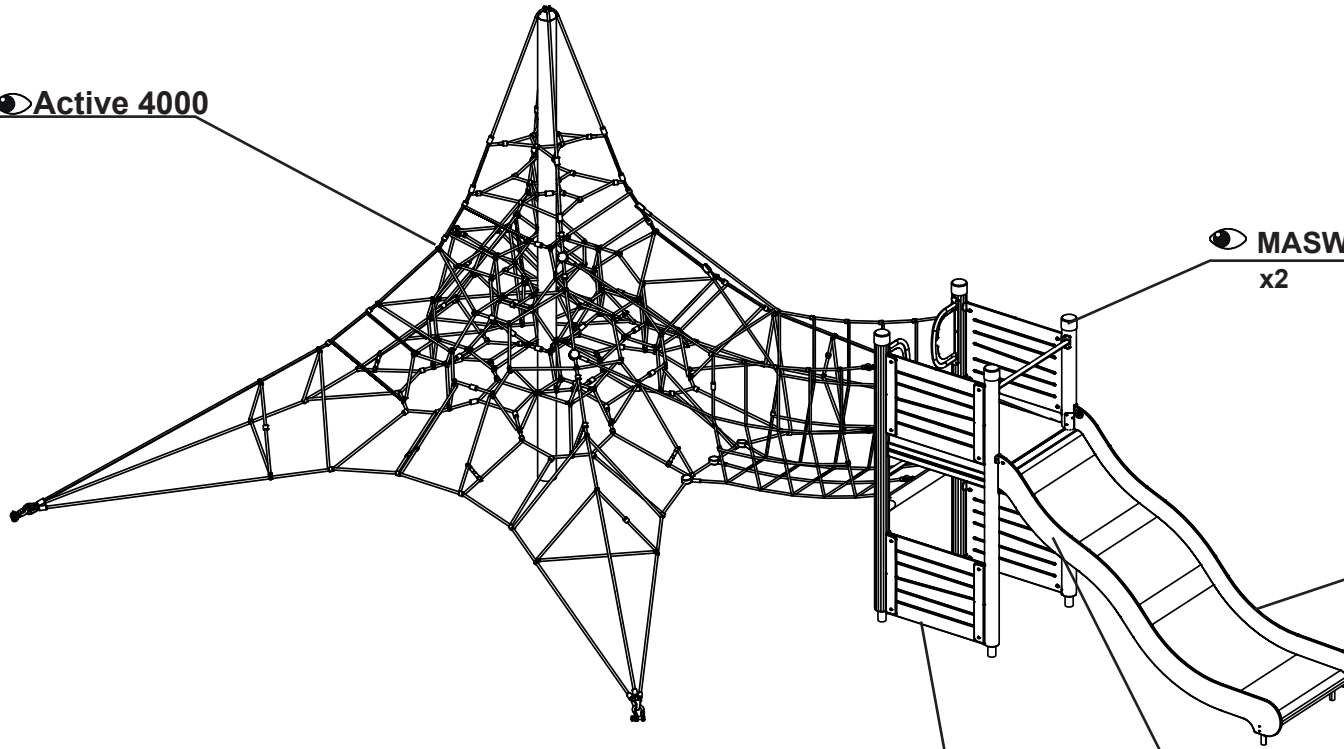

MASW39775  
x2

- MASW67941 [SF]
- MASW67923 [OM]
- MASW67943 [BM]

260329

MASW106781