

EN 1176



S6

EN1176

1.60m

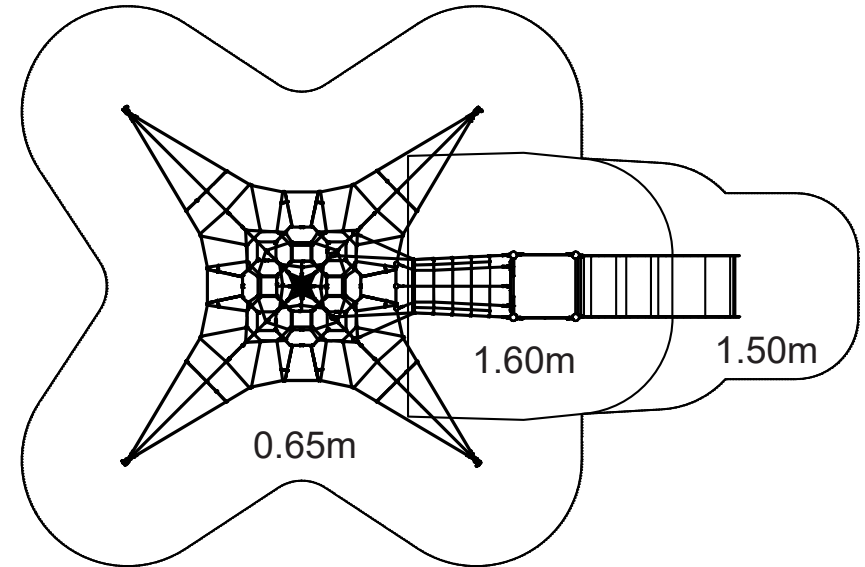
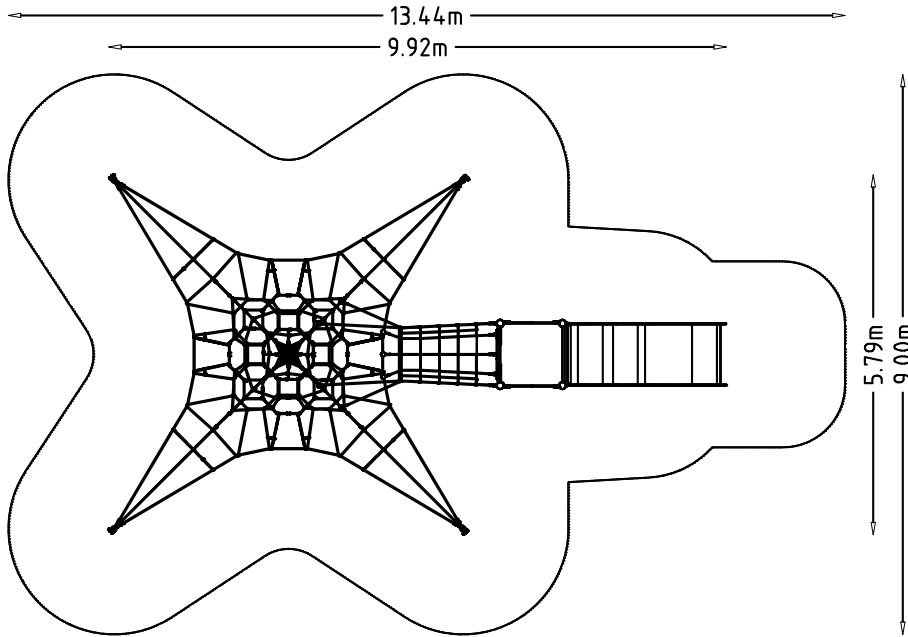

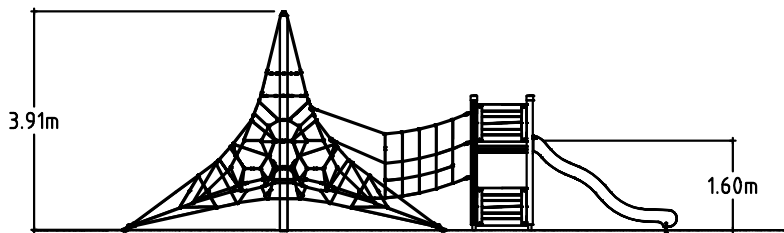
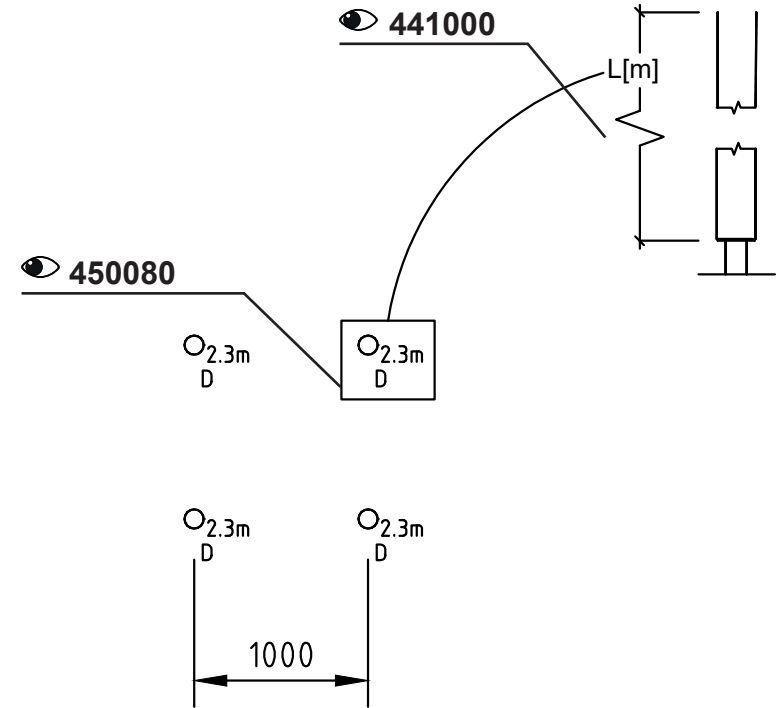
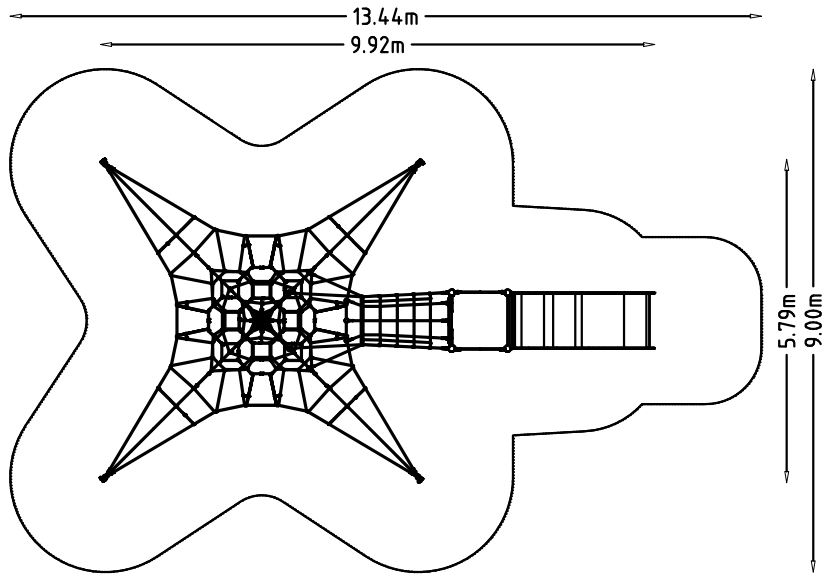

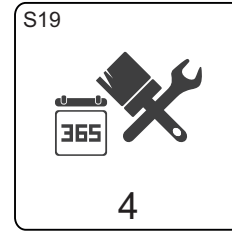
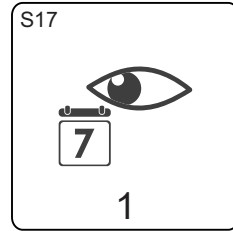
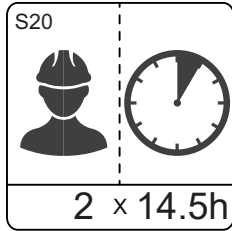

**450080**  
**441000**  
**Active4000**  
**MASW39775**  
**MASW36415**  
**MASW67953[SF]**  
**MASW67949[OM]**  
**MASW67954[BM]**  
**260329**

 **450080**

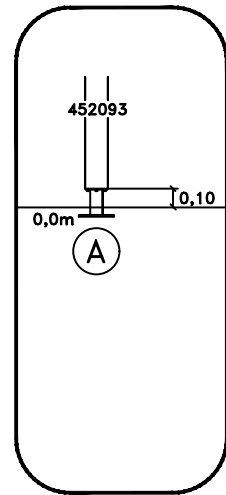

**OM**

**Above Ground**

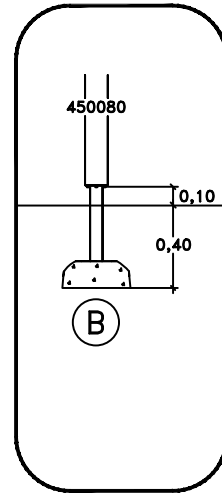

**SF**

**Sunken Foundation**

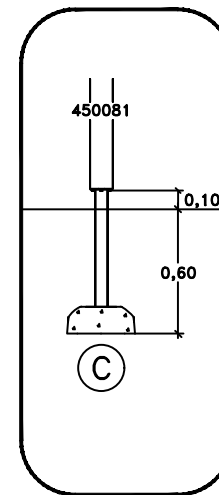

**SF**

**Sunken Foundation**

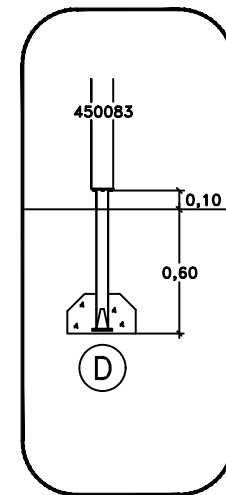

**CC**

**Cast In Place**

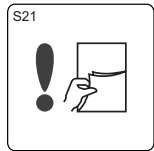
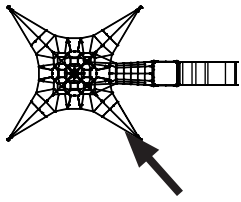

Active 4000

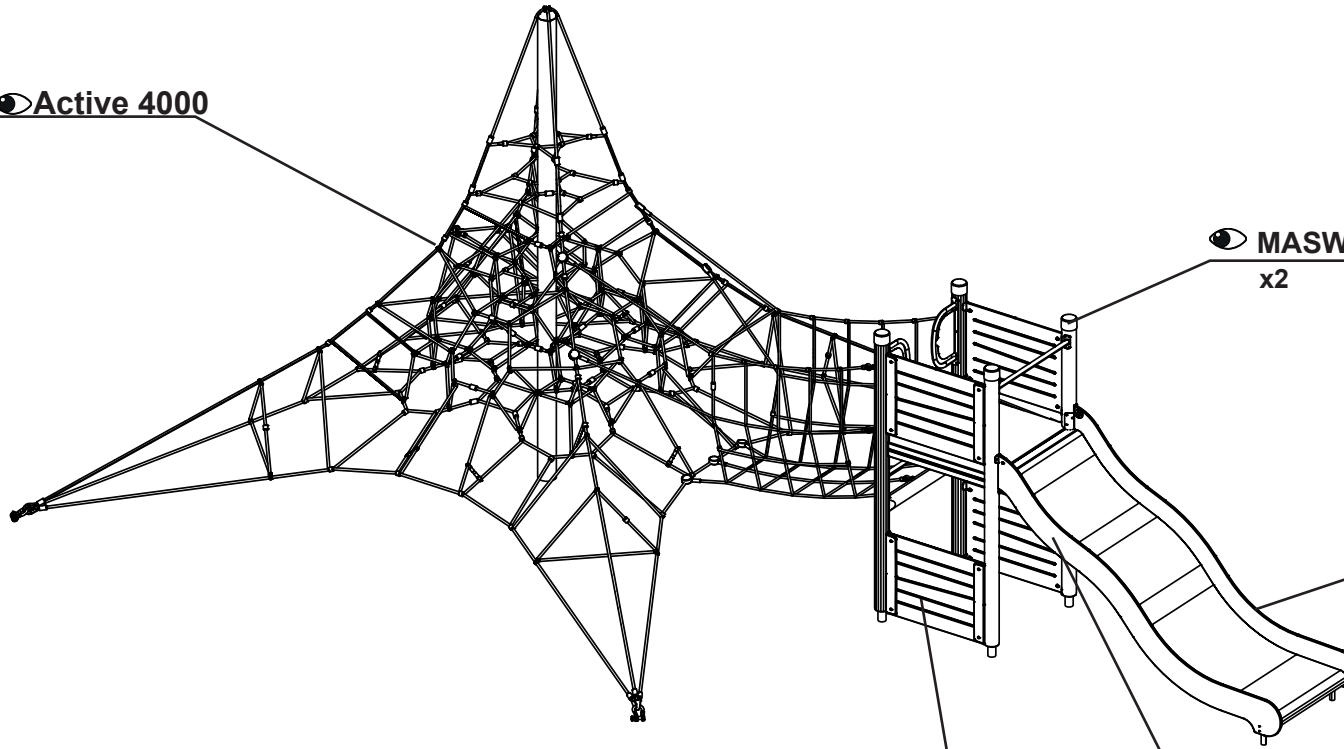

MASW39775  
x2

- MASW67953 [SF]
- MASW67949 [OM]
- MASW67954 [BM]

260329

MASW104949